

3rd IMDR **110dB***

RMDR **122dB***

BDR **150dB***

For DX Enthusiasts

HF/50MHz/70MHz TRANSCEIVER

TS-890SE2



Performance Exceeding Expectations.



The most rewarding results often take place when faced with the harshest and most challenging conditions.

There are enthusiasts who know this all too well because of their love of DX.

KENWOOD has the answer.

Achieve results through certainty and not circumstance.

Delivered through impeccable receiver and audio performance.

This is our offering to you.



HF/50MHz/70MHz TRANSCEIVER

TS-890S

<Actual Size>

396(W)×141.3(H)×340(D)mm (not including protrusions)

Top in its class with three dynamic ranges.

Alive and well, the non-tiring KENWOOD tone keeps you listening.

RECEIVER

110dB* 3rd intermodulation dynamic range (3rd IMDR)

measured under punishing 2kHz spacing conditions.

122dB* reciprocal mixing dynamic range (RMDR).

150dB* Blocking dynamic range (BDR)

All features deliver top-class receive performance.

The high-performance DSP displays its prowess

during interference-signal control,

sound-quality adjustment, and digital operation.

(*: 2 kHz spacing measurement standard - Receiver frequency 14.2 MHz,
MODE CW, BW 500 Hz, PRE AMP OFF)

Receiver



Photograph shows optional 270Hz roofing filter installed.

Receive performance on a whole other level from narrow bandwidth roofing filters that only full down conversion can provide

The TS-890S uses 8.248MHz 1st IF frequency down conversion for its receive signal system in order to continue the adjacent interference signal exclusion legacy refined in the TS-990S. This means you can use narrow bandwidth crystal filters with passband widths of 500Hz or 270Hz (optional YG-82CN-1) as roofing filters to achieve strong exclusion of unnecessary adjacent signals. The 1st mixer is the H-mode mixer also carried by the TS-990S.

Conversion characteristics have been improved with fine-tuning of input/output matching as well the device used.

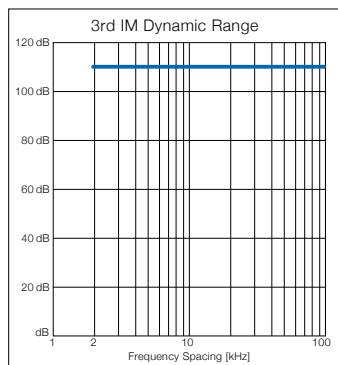

3rd intermodulation dynamic range (3rd IMDR)

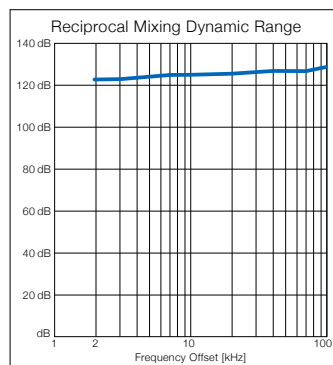

Reciprocal mixing dynamic range (RMDR)

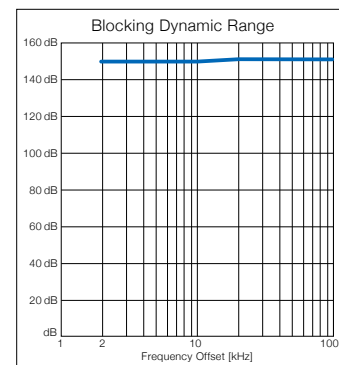

Blocking dynamic range (BDR)

Measurement conditions (shared) Frx = 14.2 MHz, PRE AMP OFF, BW 500 Hz, CW
Vertical axis: Dynamic range (shared)
Horizontal axis: Interference signal interval (3rd IMDR), interference signal isolation frequency (RMDR, BDR)
●Values are measured examples.

High-speed scanning with independent band scope receiver

The configuration of the band scope receiver has changed from the superheterodyne system used in the TS-990S to 1st IF sampling using an A/D converter (14bit/39MHz), and FPGA digital down conversion. This means a change in scanning method from step FFT to FFT, achieving high-speed updates to the display irrespective of span settings.

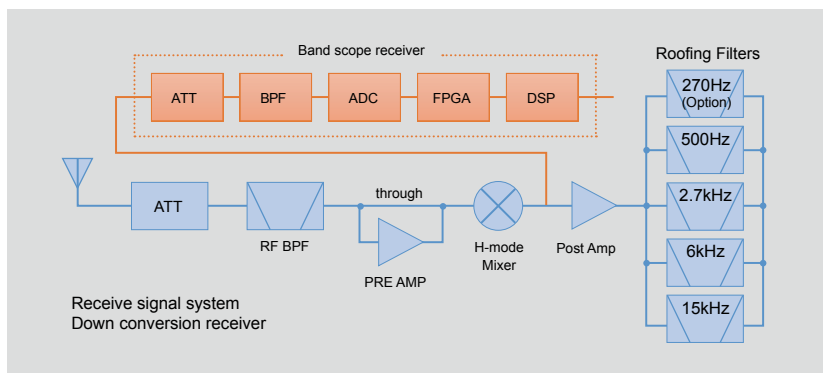



Local oscillator realizes superior C/N

Interference signal exclusion is not determined by roofing filters and signal system devices alone. The TS-890S has taken the VCO division of the TS-990S and developed it further, combining a VCO device with high C/N in the gigahertz band and a reference oscillation circuit with superior adjacent C/N to deliver C/N characteristics unattainable in conventional units.

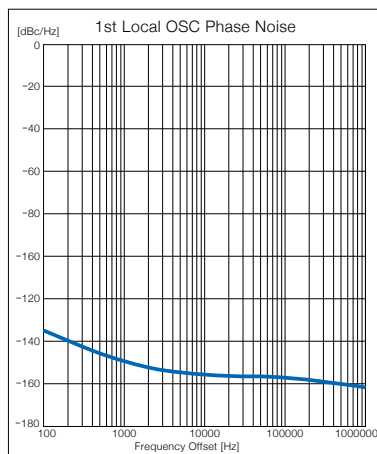
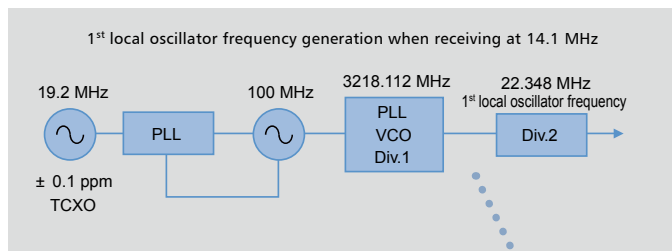

1st Local OSC Phase Noise (14.1MHz)
 ●Values are measured examples.



HMC829

Diverse interference / noise removal features

IF filter

Passband frequency range expansion through LOW-CUT/HI-CUT, WIDTH/SHIFT. Interfering signal removal and desired audio-quality adjustment, as well as more convenient operation in digital mode. Operation with LOW-CUT / HI-CUT in SSB/AM/FM mode, WIDTH/SHIFT in CW mode, and WIDTH function in FSK/PSK mode. Change to WIDTH/SHIFT operation as in CW mode also possible in SSB/SSB-DATA mode. Selection of roofing filter (270Hz*/500Hz/2.7kHz/6kHz/15kHz) can be automatic to match IF filter passband width or manual to selectable frequencies.
 (*270Hz when option mounted)

IF filter shape, AF filter

Switching is possible between 3 kinds of IF filter shapes: Medium/Soft/Sharp. Switching is also possible for post-demodulation voice-audio between 3 kinds of AF filter passbands: Medium/Wide/Narrow. Combinations of these settings can adjust the sharpness of the demodulation signal.

Audio peak filter

This is a narrow bandwidth peak filter operated during receive in CW mode. When intelligibility is low due to noise, it has the effect of floating the target signal and increasing intelligibility. The central frequency is linked to the pitch frequency, and can be given a maximum peak gain of +6dB.

Notch filter

A notch filter that operates in the IF stage. By eliminating strong interfering signals, it allows weak target signals to stand out. Damping range can be switched between three levels: Narrow/Middle/Wide, enabling operation to match interference conditions.

Noise reduction function (NR1/NR2)

In addition to conventional NR1/NR2 noise reduction, NR1 comes equipped with noise reduction using spectral-subtraction, which focusses on noise reduction in voice-audio system modes. The optimum noise reduction method is applied for each receive mode.

Noise blanker

A noise blanker reduces crackling, pulse-type noise. The TS-890S includes two kinds of noise blankers: NB1, which processes analogue signals, and NB2, which carries out digital processing in the IF stage using DSP. Furthermore, selection of NB2 can be made from two kinds of NB with different operating principles. Either NB1 or NB2 can be used depending on noise conditions, or both can be used simultaneously.

Beat cancel function (BC1/BC2)

While a notch filter (IF stage) is effective for a single strong beat, beat cancelling (AF stage) shows results on multiple, comparatively weak beats. BC1 is effective on weak beats and continuous beats, while BC2 is effective on intermittent beats like CW signals.

AGC Quick recovery

A function to recover from suppression that happens when pulse noise is included in a receive signal.

The speed and quality of KENWOOD'S renowned IF AGC control

A variety of functions are realized through 32-bit floating-point DSP technology inherited from the TS-990S, including modulation/demodulation in all modes, IF filter, IF-AGC, and removal of interfering signals. Popular for its non-tiring and great-quality audio, the IF-AGC has undergone a facelift with a combination of roofing filters and IF filters, and has been designed to enable optimal control under various noise circumstances.



For IF DSP, transmitter
 ADSP-21363 clock @332MHz



For band scope
 ADSP-21363 clock @332MHz

Other receiver system features

- RF ATT(OFF/6/12/18dB)
- Preamp(PRE1/PRE2)
- Receive only antenna connector(RX IN, RX OUT)
- Antenna output connector

Evolved power to perform with diverse displays and auto-scroll.
A transmitter with stable output, quietness and high speed.

Display / Transmitter

The unit carries a high definition 7-inch TFT color display.

In addition to a diverse range of display content, the convenient AUTO SCROLL MODE provides strong support for competition or similar operation. Other strengths include clean and stable 100W* transmitter output, improved quietness from twin cooling fans, and high-speed operation enabled by an auto antenna tuner.



LCD Display/Transmit

*70 MHz band is 50 W

Operational capacity reinforced with displays and various features



The seven-inch TFT color LCD is the same size as that used in the TS-990S. In addition to basic information including frequency, mode, and S-meter, the band scope and audio scope are also displayed. The TS-890S also displays further improvements in visibility and operability in tough usage scenarios such as competitions.

With the spectrum scope and waterfall screen display, the analogue meter is simultaneously displayed. The popular sub-scope display from the TS-990S has been incorporated as a filter-scope display

● CENTER MODE

When changing the receive frequency in CENTER MODE, there are many units that display a bright line that flows obliquely over the waterfall, but with the TS-890S, the bright line remains straight and enables tuning operation*. Switching to the follow display is also possible via the menu.

*: During straight display, the waterfall bright line temporarily stops and undergoes parallel displacement. Image becomes slightly coarse when expanded.

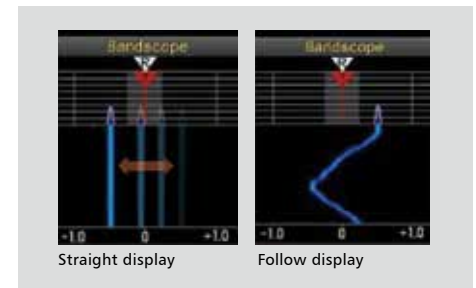

A band scope providing ease-of-use

● AUTO SCROLL MODE

In addition to conventional CENTER MODE and FIXED MODE, the unit comes equipped with an AUTO SCROLL MODE. While in FIXED MODE, if the receive frequency goes over the scope edge, then auto-scroll will engage for half a screen width. Furthermore, with the EXPAND function turned on, the screen to be displayed next can be drawn in advance*. Also, with the SHIFT function, the receive marker can be set in the desired position on the vertical grid, which is convenient when displaying a non-receive frequency as the center display, such as for pileups during splits. *: Effective in spans under 200kHz. Image becomes slightly coarse when expanded.

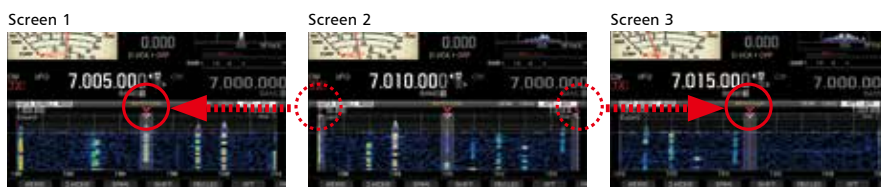

Auto-scroll operation (span 10 kHz, EXPAND ON) On the current screen (screen 2), if the frequency is changed to go over the top end of screen 2, it will automatically change to screen 3, and if it goes over the bottom end of screen 2, it will automatically change to screen 1. Waterfall screen creation normally commences after switching screens, but with the EXPAND function turned to ON, the display switches to the finished screen.

● FIXED MODE

FIXED MODE allows you to switch between three kinds of display ranges with a single touch of the panel screen. The initial value is preset based on the band plan, but this can be easily adjusted to a desired scope.

Improved reference level operability ease-of-use

The TS-890S has improved operability of the reference level focusing on the visibility of the waterfall. ●Through optimization of each span, readjustment is mostly unnecessary when switching between them.* ●Settings are enabled for each band, and readjustment is also unnecessary for the PRE AMP ON and PRE AMP OFF bands.

*: Spectrum scope waveform height changes during span switching.



Filter scope display

The popular sub-scope from the TS-990S is carried as a filter scope display. You can confirm receive filter selection status, roofing filter bandwidth, IF filter passband information, receive for ex-audio spectrum, CW pitch frequency, and notch frequency all concentrated in one location.



CW mode display example



SSB mode display example

Other display system features

●Transmit digital meter enabling display of two kinds of transmit information even during analog meter display ●Audio scope (spectrum scope, oscilloscope) able to be displayed simultaneously with reduced band scope ●Band scope IF filter passband with display ●Change of gradation for waterfall display ●Frequency marker display function (Max. 50) ●Transmit spectrum display (during CENTER MODE) ●SWL display mode

Expanded touch operation scope

Basic operation of the TS-890S is through knobs and switches with a definite 'clicking' feel rather than touchscreen operation, but the below adjustment features and menu settings can now be changed via touch operation.

RX/TX equalizer level adjustment, meter type (analog white / analog black / bar meter) switching, FFT scope/X-Y scope switching on RTTY decode screen, FFT scope/vector scope switching on PSK decode screen, voice-audio file playback position change. Furthermore, with touchscreen tuning, in addition to the conventional CW tuning operation via long-push, a short push enables tuning using steps set via MULTI/CH, while on bands popular with operation in units of 1kHz, practical touch alignment is possible even in SSB.

Heavy-duty design delivers transmission performance able to withstand long hours of operation.

Highly reliable 100W final-stage amplifier circuit. (*70 MHz band is 50 W)

The final-stage amplifier device is a Mitsubishi-made MOSFET RD100HHF1 (Pch 176.5W) operating in push-pull. A MOSFET RD16HHF1 has been used for the drive amp, and a MOSFET RD06HHF1 for the pre-drive amp. Inter-stage matching and fine-tuning delivers superior transmit IMD even for a 13.8V final circuit, enabling operation with a clean and low-distortion signal.

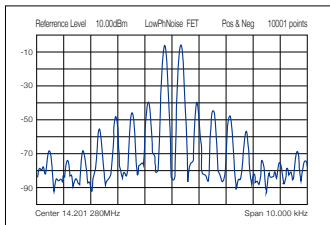

14MHz transmit IMD example (100W output)
 ●Values are measured examples.

Heavy-duty design with improved quietness

The unit employs a twin cooling fan system that uses a pair of 80 x 80 mm fans. Using two fans provides sufficient air flow at low rpm, making for superior quietness. The quietness level for the fans when operating has been improved by more than 5dB compared to our conventional models. Furthermore, the use of an aluminum die-cast chassis combined with a large heat sink makes for a heavy-duty design sufficiently capable of withstanding the tough conditions typical of contests or long hours of hard operation.



The position of the heatsink in the center of the rear panel

Built-in high-speed automatic antenna tuner enabling high-speed operation



The antenna tuner is a preset type also operable during receive and covering amateur bands from 1.8MHz~70MHz. High-speed operation and the proven relay method enable rapid QSY through instantaneous band changing. The menu can be used to set an ON/OFF memory for the antenna tuner for each band.

Free settings enabled through linear amp control settings menu

A variety of linear amp connections have been taken into account, including self-made ones, and independent settings for various kinds of control at HF/50MHz, 70MHz bands are possible. Possible settings include: linear amp ON/OFF, transmission control (H active, L active), transmission delay ON/OFF, transmission delay time (CW/FSK/PSK) and (SSB/AM/FM), internal relay control, and external ALC threshold voltage adjustment.

TCXO as standard, high frequency stability at ± 0.1 ppm

Equipped with a TCXO (temperature compensated crystal oscillator) requiring no warm-up as standard, high stability of ± 0.1 ppm has been obtained in a wide temperature range covering from 0°C~+50°C. External standard signal (10MHz) input is also possible.

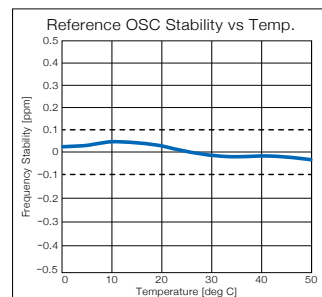

TCXO temperature drift characteristics
 ●Values are measured examples.

Other transmit system features

●USB keying/SEND ●DRV connector output (supports transmission in 137kHz and 475kHz bands) ●Transmit output limiter (supports ON/OFF switching, mode settings) ●TX tuning

Delivering the ultimate in split-operation operability. An interface that thinks of everything.

Operability

A variety of features achieve speedy split operation even with a single receiver.
Speedy split frequency settings,
split status band switching
via a band direct key,
and support for external TF watch
via an external receiver.
A panel layout enabling intuitive handling
makes for comfortable operation.

Control

Stronger split-operation handling through VFOA/B

● Split frequency settings

In addition to conventional split frequency setting methods, the TS-990S's proven split setting functions have been included. For 2kHz UP, press '2' on the number pad after a long press of the SPLIT key and the settings are complete. Split frequencies can be set within the range of ± 9 kHz (1kHz steps).



Band direct key

● Band changing possible while keeping split settings for each band (menu setting feature)

In the split state, changing the band or band memory via the band direct key will make changes while keeping the split state. Individual settings are possible for the split frequencies and modes for each band memory, which is convenient for chasing DX-peditions during multiband/mode operation.



7MHz band CW 2kHz UP



14MHz band SSB 5kHz UP

● Split frequency changing (menu setting feature)

In addition to the conventional method of operating the tuning knob during TF-SET, when RIT/XIT is not in use, the split frequency can also be changed by operating the RIT/XIT knob.



● Split frequency receive via external receiver (menu setting feature)

By connecting another TS-890S or TS-590S/SG*1 unit to the ANT OUT connector to use as a sub-receiver*2 and using the split transfer function A, this can enable assistance in 2-wave simultaneous receive during split operation*3.

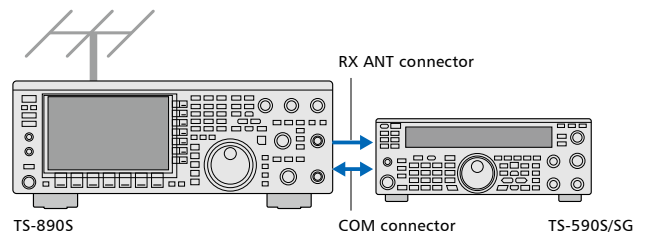

IF filter A/B/C one-touch switching

Three kinds of bandwidth presets and instantaneous switching are possible for IF filters. Switching can also be limited to 2 kinds, so this enables use for wide/narrow switching. Using the FIL.CLR key, a changed bandwidth can be returned to a preset frequency with a single touch.



*1: Requires a firmware update. *2: Loss of approximately 3dB (theoretical value) is experienced *3: Frequency transfer, standby, and sub-receiver audio mute are possible. Requires separate antenna cable and RS-232C cross-cable. Not compatible with combined SP/headphone use.



CW Morse code decode/encode possible with stand-alone unit

The unit is compatible with CW Morse code decode/encode. Transmission of Morse code is possible with text input from a USB keyboard. Combined use of templates sent from message memories and Morse code transmissions via panel is also possible. Dedicated decode filter switching, and functions for transmission logs and output of decoded text to PC are also included.



CW decode/encode screen

FSK/PSK functions

- RTTY basic operation settings (keying polarity, shift width, HI/LO tones, reverse mode)
- Compatible with PSK31 (QPSK, BPSK) and PSK63 (BPSK)
- RTTY/PSK operation via on-board decoder/encoder (USB keyboard compliant)
- Message memory function
- Tuning scope display (audio FFT, waterfall/X-Y scope (FSK)/vector scope (PSK))

Compatible with FM operation on 28MHz, 50MHz, and 70MHz bands

The unit includes switching to FM narrow for transmit and receive, as well as repeater operation support and FM signaling functionality (CTCSS, cross-tone).

DATA mode compatible with external input/output switching

*** Not supported on E2 Type (for UK)

Separate from the microphone connector, the back panel includes a variety of I/O interfaces, including analogue audio input and output, USB audio interface, and LAN(VoIP)interface***. By combining DATA mode with SSB/FM/AM modes, it is possible to freely set channels for modulation and demodulation. Furthermore, combined use with DATA VOX enables the transmission of modulation signals from a PC, rendering standby wiring and commands unnecessary.

Remote operation achieved without host PC Direct remote-control function (KNS)

Not supported on E2 Type (for UK)

When operating using the KNS (KENWOOD Network Command System), remote operation of the radio as possible by a direct LAN connection. Conventional connection using a host PC and ARHP (Amateur Radio Host Program) is also possible.

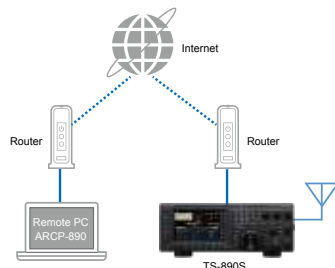

USB memory/USB cable firmware update function

Starting the unit in update mode and inserting a USB memory stick containing firmware into the front USB-A port will start an automatic update. Updates can also be carried out by connecting the TS-890S to a PC via a USB cable, and moving a firmware file using drag & drop on top of the 'TS-890S' removable device that is displayed on the PC's desktop during update mode.

Recording functions

The TS-890S comes equipped with a 1GB internal memory, and can record a maximum of roughly 9 hours of audio without using USB memory*. When using USB memory, depending on the capacity, there are no limits on the amount of audio recording. Recording options include normal, constant, and timer, and recording can also be linked to the squelch.

*: Other files sharing memory capacity may result in less than 9 hours.

Diverse functions supporting CW operation

- PADDLE/KEY jack (one each on front/rear, compatible with paddle/straight key switching)
- CW auto tuning
- Full break-in and semi break-in (semi break-in delay time: 50ms~1000ms)
- CW Pitch control, Side tone (pitch frequency linking 5Hz steps)
- Built-in electronic keyer (key speed settings, keyer mode A/B selection)
- 8CH CW message memory function
- Auto-switch to CW mode on keydown in SSB mode
- Microphone paddle mode
- CW auto wait/wait reverse
- CW reverse mode / CW BFO side band switching

Other operation functions, main connectors

- 120 channel memory
- XIT shift enabling one-touch transition to split mode from XIT operation
- Main knob fast-forward
- CONFIG A/B function enabling overall switching of menu and all settings depending on operation environment.
- Voice guidance function
- ID beep function notifying callsign transmission guide
- 3 PF keys
- Screen capture
- User screen slideshow screensaver
- LAN connector Not supported on E2 Type (for UK)
- USB-A connector (1 each on front/rear)
- CW auto wait/wait reverse
- USB-B connector
- External display connector (DVI-I)
- KEYPAD jack (add up to 8 external PF keys)
- External analogue meter output
- Packet cluster tuning

KENWOOD SKY COMMAND® II support

(When connected to TH-D72E/TM-D710E*/TM-D710GE)**

Enables full-duplex operation with improved functionality such as visual confirmation of HF frequency on the LCD panel. Control via TNC (AX.25) enables more accesses to HF functions: XIT, mode switching, split-frequency operations on/off, memory shift, and frequency step selection. The transporter sends out its pre-programmed call sign via CW every 10 minutes.

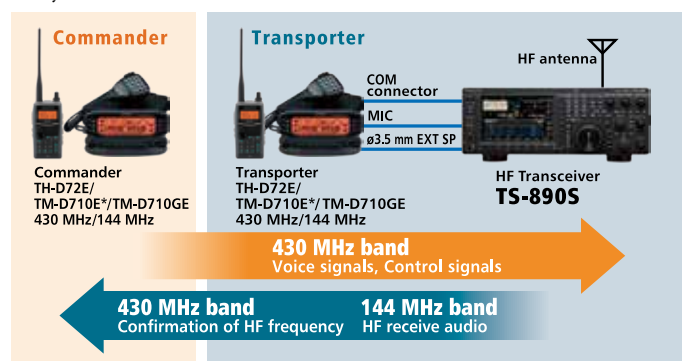

*Discontinued product

**KENWOOD SKY COMMAND® II uses a pair of TH-D72E or TM-D710E*/TM-D710GE transceivers.

Note: Refer to applicable Amateur Radio regulations to check whether you are permitted to use this function.

Front/Rear Panel

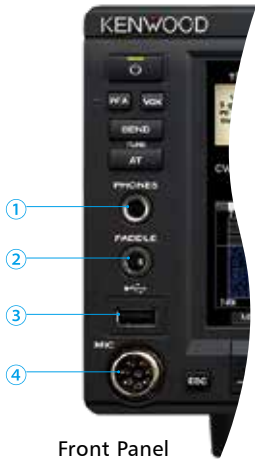

Front Panel

Front Panel

- ① [PHONES] Jack (φ6.3): For Connecting Headphones
- ② [PADDLE] Jack (φ6.3) : For Connecting CW Operation Paddle
- ③ [USB-A] Connector: For USB Memory, USB Keyboard
- ④ [MIC] Connector (8 Pin Metal Type): For Connecting Microphone

Back Panel

- ① [ANT 1, ANT 2] Antenna Connectors (M-type)×2
- ② [AT] Connector (6 Pin): For Connecting External Antenna Tuner
- ③ [RX IN] Connector (RCA): For Connecting Receive Only Antenna
- ④ [RX OUT] Connector (RCA): For Connecting External Receiver
- ⑤ [DRV] Connector (RCA): Drive Output
- ⑥ [ANT OUT] Connector: For Antenna Signal Distribution to External Receiver
- ⑦ [DC13.8V] Connector (4 Pin): For Connection of DC Power Source
- ⑧ [REF IN(10MHz)] Connector (BNC): For Standard External Signal Input
- ⑨ [KEYPAD] Jack(φ3.5): For Connection of External PF Key
- ⑩ [COM] Connector(D-SUB 9 Pin: For PC Control
- ⑪ [USB-A] Connector: For USB Memory, Keyboard
- ⑫ [GND] Terminal: For Connection of Earth
- ⑬ [KEY] Jack(φ6.3): For Paddle, Straight Key, and PC Keying
- ⑭ [ACC2] Connector(13Pin DIN): For Connection of Audio I/O and Other Accessories
- ⑮ [REMOTE] Connector(7Pin DIN):For Connection of Linear Amplifier
- ⑯ [METER] Jack(φ3.5):For Connection of Commercial Analog Meters
- ⑰ [EXT.SP] Jack(φ3.5):For Connection of External Speakers
- ⑱ [USB-B] Connector:For PC Control, USB Audio
- ⑲ [DISPLAY] Connector(DVI-I):For Connection of External Display
- ⑳ [LAN] Connector(RJ-45):For PC Control (KNS) Not supported on E2 Type (for UK)

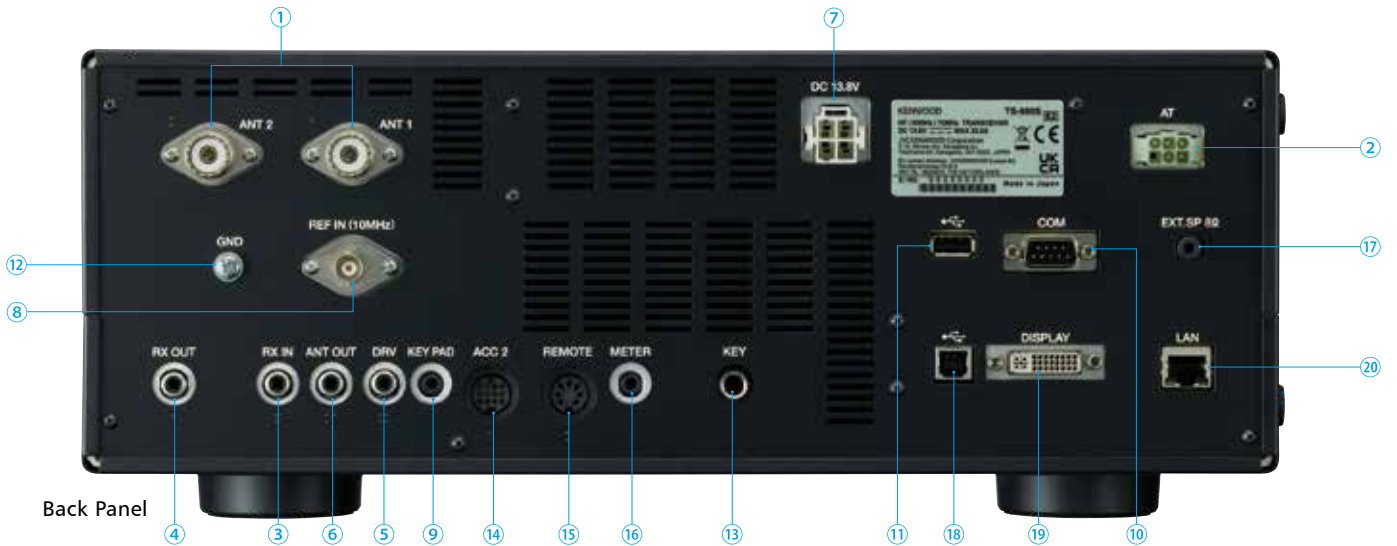

Back Panel

Main Options

SP-890 External Speaker



The SP-890 has a design that matches the TS-890S, and achieves a frequency response with good intelligibility. Through the use of high-cut and low-cut filters, the receive sound is at a basic setting that allows the adjustment of its timbre to suit your preferences.

HS-5 Open-Air Headphones



YG-82CN-1 270Hz CW Filter



A narrow-band roofing filter that removes ultra adjacent interference signals.

ARCP-890 Software Radio Control Program



Not supported on E2 Type (for UK)

Software to control your TS-890S remotely from your PC. Band scope can also be used for KNS operation. (LAN connection recommended.)



ARHP-890 Software Radio Host Program

Software to use on the host side when controlling your TS-890S remotely over a network.



ARUA-10 Ver. 4.00 and later Software USB Audio Controller

Software to use the speakers and microphone of a PC connected by a USB cable in place of the radio unit's speaker and microphone.



ARVP-10 Ver. 1.03 and later Software VoIP Program

Software to relay voice-audio between a host-side radio and remote-side PC connected over a network through the KENWOOD Network Command System.

*The above software is freeware that will be available for download from KENWOOD website.

Receiver LCD Display/ Transmit Control Specifications



TS-890S Specifications

General		
Frequency range (Transmitter)	160m band	1.81 ~ 2.0 MHz
	80m band	3.5 ~ 3.8 MHz
	60m band *1	5.25 ~ 5.45 MHz
	40m band	7.0 ~ 7.2 MHz
	30m band	10.1 ~ 10.15 MHz
	20m band	14.0 ~ 14.35 MHz
	17m band	18.068 ~ 18.168 MHz
	15m band	21.0 ~ 21.45 MHz
	12m band	24.89 ~ 24.99 MHz
	10m band	28.0 ~ 29.7 MHz
6m band	50.0 ~ 52.0 MHz	
4m band	70.0 ~ 70.5 MHz	
Frequency range (Receiver)		0.13 ~ 30 MHz, 50 ~ 54 MHz, 70.0 ~ 70.5MHz VFO: Continuous 30 kHz ~ 74.8 MHz
Mode		A1A(CW), A3E(AM), J3E(SSB), F1B(FSK), F3E(FM), G1B(PSK)
Frequency stability		±0.1 ppm, 0 °C ~ +50 °C
Antenna impedance		50 Ω
Antenna tuner load range		16.7 Ω ~ 150 Ω
Supply voltage		DC 13.8 V ± 15 %
Ground		Negative ground
Current Drain	TX	22.5 A or less
	RX (No signal)	2.5 A or less
Operating Temperature		0 °C ~ +50 °C
Dimensions	Without projections	W396.0 × H141.3 × D340.0 mm
	With projections	W409.6 × H158.3 × D387.4 mm
Weight		Approx. 15.8 kg
Transmitter		
Output Power (AM)		HF/50MHz: Max 100 W / Min 5 W, (Max 25 W / Min 5 W) 70MHz: Max 50 W / Min 5 W, (Max 12.5 W / Min 5 W)
Modulation		SSB: Balanced, AM: Low Power, FM: Reactance
Maximum frequency deviation (FM)		wide: ±5 kHz or less, narrow: ±2.5 kHz or less
Spurious emissions		HF: -50 dB or less 50 MHz: -63 dB or less 70 MHz: -60 dB or less
Carrier suppression		60 dB or more
Unwanted sideband suppression		60 dB or more
Transmit frequency response		Within -6 dB (100 ~ 2,900 Hz)
Microphone impedance		600 Ω
XIT variable range		±9.999 kHz

Supplied accessories

- DC power cord x1
- 7pin DIN Plug (For REMOTE connector x1)
- 13pin DIN Plug (For ACC2 connector x1)
- Spare Fuse 4A x1
- Spare Fuse 25A x1
- Operation Manual x1
- Warranty Card x1

Receiver		
Circuit type		Double Superheterodyne
Intermediate frequency	1st IF	8.248 MHz
	2nd IF	24 kHz / 36kHz (FM)
Sensitivity (TYP)	SSB / CW / FSK / PSK (S/N 10 dB)	0.5 μV (0.13 ~ 0.522 MHz)
		4 μV (0.522 ~ 1.705 MHz)
		0.2 μV (1.705 ~ 24.5 MHz)
		0.13 μV (24.5 ~ 30 MHz)
		0.13 μV (50 ~ 54 MHz)
	AM (S/N 10 dB)	0.13 μV (70 ~ 70.5 MHz)
		6.3 μV (0.13 ~ 0.522 MHz)
		31.6 μV (0.522 ~ 1.705 MHz)
		2 μV (1.705 ~ 24.5 MHz)
		1.3 μV (24.5 ~ 30 MHz)
FM (12 dB SINAD)	1.3 μV (50 ~ 54 MHz)	
	1.3 μV (70 ~ 70.5 MHz)	
	0.22 μV (28 ~ 30 MHz)	
	0.22 μV or less (50 ~ 54 MHz)	
	0.22 μV or less (70 ~ 70.5 MHz)	
Squelch Sensitivity	SSB / CW / FSK / AM	5.6 μV or less (0.13 ~ 0.522 MHz)
		18 μV or less (0.522 ~ 1.705 MHz)
		1.8 μV or less (1.705 ~ 30 MHz)
		1.1 μV or less (50 ~ 54 MHz)
		1.1 μV or less (70 ~ 70.5 MHz)
	FM	0.2 μV or less (28 ~ 30 MHz)
		0.2 μV or less (50 ~ 54 MHz)
		0.2 μV or less (70 ~ 70.5 MHz)
		0.2 μV or less (70 ~ 70.5 MHz)
		0.2 μV or less (70 ~ 70.5 MHz)
Image Rejection Ratio		HF:70 dB or more, 50/70 MHz: 60 dB or more
IF Rejection Ratio		70 dB or more
Selectivity	SSB	2.6 kHz or more (-6 dB)
		4.4 kHz or less (-60 dB)
	CW / FSK	500 Hz or more (-6 dB)
		1.2 kHz or less (-60 dB)
	AM	6.0 kHz or more (-6 dB)
12 kHz or less (-50 dB)		
FM	12 kHz or more (-6 dB)	
	25 kHz or less (-50 dB)	
RIT variable range		±9.999 kHz
Notch filter attenuation		60 dB or more (Auto), 70 dB or more (Manual)
Beat cancel attenuation		40 dB or more
Audio output		1.5 W or more (8 Ω)
Audio output impedance		4 Ω ~ 8 Ω

Dimensions

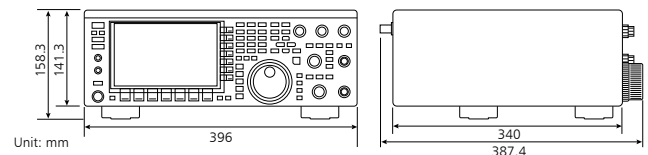

*1 60 m band: Refer to applicable Amateur Radio regulations to your country.

Electronic specifications apply only to amateur bands. Receive sensitivity drops in the vicinity of the 1st IF frequency (8.248MHz) due to IF trapping. Internal beat may occur during amateur band receive. Band scope (waterfall) screen may also display spurious signals other than receive signal.

KENWOOD SKY COMMAND SYSTEM II is a registered trademark of JVCKENWOOD Corporation in the U.S.

JVCKENWOOD follows a policy of continuous advancement in development.

For this reason, specifications may be changed without notice.

*Alterations may be made without notice to improve the ratings or the design of the transceiver.

*The photographic and printing processes may cause the coloration of the transceiver to appear different from that of the actual transceiver.

JVCKENWOOD U.K. Limited

First Floor, Gleneagles, the Belfry, Colonial Way, Watford,
Hertfordshire WD24 4WH, United Kingdom

<https://kenwoodcommunications.co.uk/comm/>



ISO9001 Registered
Communications Systems Division
JVCKENWOOD Corporation